

Double Width Tower
1.8m Long x 1.45m wide

Working Height
7.7m

Platform Height
5.7m

Tower Components

Item	Description	Quantity
1	150mm Locking Castor	4
2	Adjustable Leg 500mm	4
3	2 rung Ladder Frame	1
4	2 rung Span Frame	1
5	3 rung Ladder Frame	1
6	3 rung Span Frame	1
7	4 rung Ladder Frame	2
8	4 rung Span Frame	2
9	1.8m Trapdoor Platforms	2
10	1.8m Standard Platforms	1
11	1.8 m Horizontal Brace	10
12	2.1 m Diagonal Brace	10
13	Complete Toe Board Set	1
14	Standard Stabilisers	4
15	Jumbo Stabilisers	0
16	Instruction Manual & BSEN1004 certificate of conformity	1

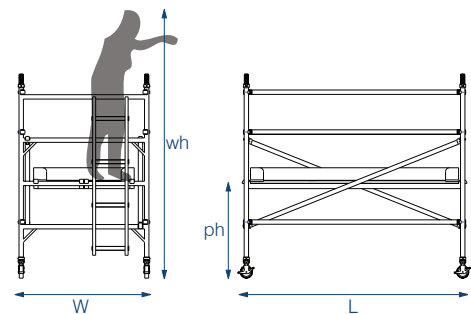
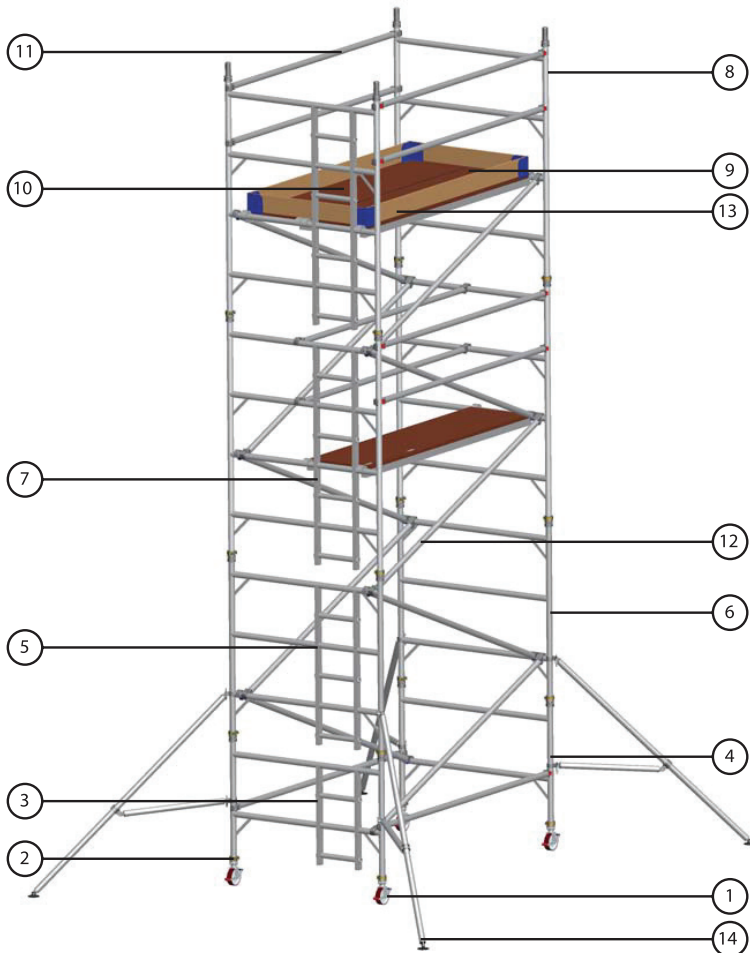

Technical Information

Base Dimensions:	(L)1.8m X (W)1.45m
Maximum Platform Height (ph):	5.7m
Maximum Working Height (wh):	7.7m
Maximum Working Load Per Platform:	275kg
Maximum Working Load Per Tower: (including tower weight)	950kg
Weight:	201kg