

Double Width Tower
1.8m Long x 1.45m wide

Working Height
7.2m

Platform Height
5.2m

Tower Components

Item	Description	Quantity
1	150mm Locking Castor	4
2	Adjustable Leg 500mm	4
3	2 rung Ladder Frame	0
4	2 rung Span Frame	0
5	3 rung Ladder Frame	0
6	3 rung Span Frame	0
7	4 rung Ladder Frame	3
8	4 rung Span Frame	3
9	1.8m Trapdoor Platforms	2
10	1.8m Standard Platforms	1
11	1.8 m Horizontal Brace	10
12	2.1 m Diagonal Brace	9
13	Complete Toe Board Set	1
14	Standard Stabilisers	4
15	Jumbo Stabilisers	0
16	Instruction Manual & BSEN1004 certificate of conformity	1

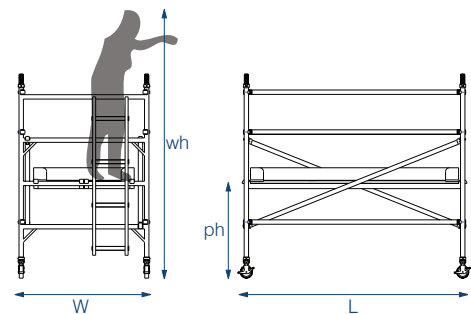
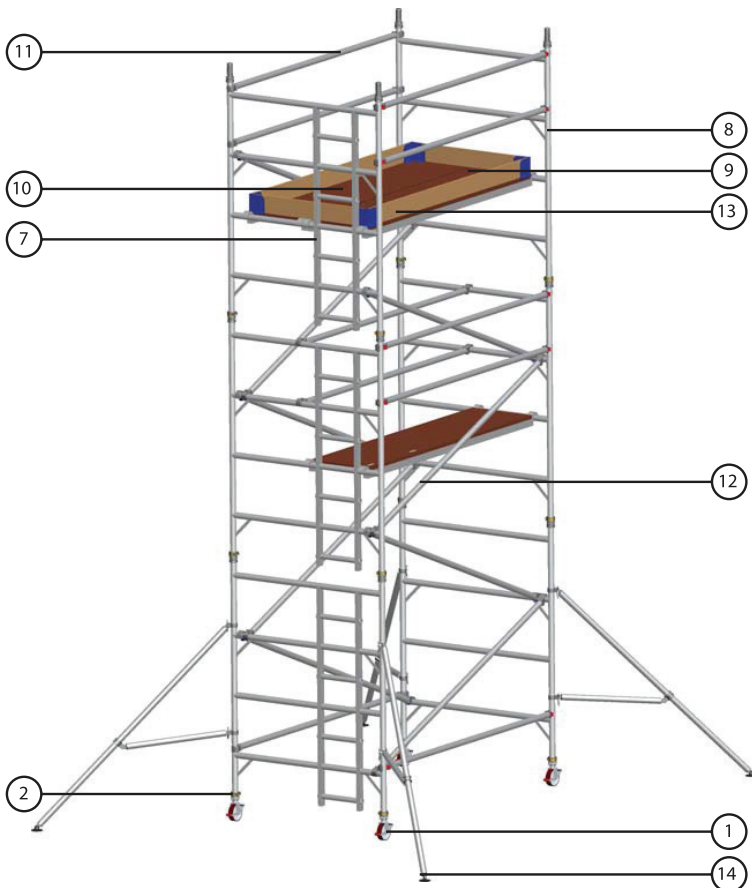

Technical Information

Base Dimensions:	(L)1.8m X (W)1.45m
Maximum Platform Height (ph):	5.2m
Maximum Working Height (wh):	7.2m
Maximum Working Load Per Platform:	275kg
Maximum Working Load Per Tower: (including tower weight)	950kg
Weight:	189kg